

AI56 Acoustic imaging camera



The HIKMICRO AI56 acoustic imaging camera is a professional product for gas leak detection and partial discharge detection. With 64 Low-noise MEMS microphones and an adjustable bandwidth range from 0 kHz to 96 kHz, AI56 provides an easy and effective way to locate pressurized air leaks in industrial environments or detect partial discharge in electric systems. By adopting this lightweight and easy-to-use tool, you can discover potential safety risks, minimize troubleshooting, and save extra costs for equipment failures and downtime.

Key Features

- 64 Low-noise MEMS Microphones, real-time sound source localization
- Real-time estimated leak rate, leak cost, and leak level for gas leak detection
- Partial discharge detection can identify corona, floating, surface, and particle discharges
- Analyzer acoustic software for analyzing images and export reports.
- 800 × 480 Resolution, 4.3'LCD Touch Screen
- Supports 8 acoustic palettes

• Specification

| Acoustic | |
|---------------------------------------|--|
| Number of Microphones | 64 |
| Acoustic Image Resolution | 800 × 480 |
| Bandwidth | 0 kHz to 96 kHz, adjustable range MEMS sampling frequency: 192 kHz |
| Distance | 0.3m~150m |
| Acoustic Image Palette | White Black, Black White, Rainbow, Fusion, Ironbow, Red Black, Rain, Blue Red |
| Camera FOV | 50.2°× 35.4° |
| Sound Intensity Display | Peak Point |
| Acoustic Image Frame Rate | 25 fps |
| Dynamic Range | Low Limit: <-15dB High Limit: >120dB |
| Leak Rate | >0.008 l/min @ 6 bar from 0.5 m (1.64 ft) >0.013 l/min @ 5 bar from 1 m (3.28 ft) |
| Discharge Detection | Automatic detection 50 / 60 Hz |
| Discharge Type | Corona Discharge, Particle Discharge, Floating Discharge, Surface Discharge |
| Image Display | |
| Display | 800 × 480 Resolution, 4.3'LCD Touch Screen |
| Screen Brightness | Manual/Auto |
| Digital Zoom | 1.0x to 16.0x continuous |
| Data Storage and Communication | |
| Storage Media | Removable 64 GB SD Card |
| Image Storage Capacity | 20,000 images |
| Annotations | Voice note: max. 60 seconds; Text note: max. 255characters |
| Video Storage Capacity | 60 hours |
| Video File Format | MP4 |
| General | |
| Wi-Fi | 802.11 b/g/n (2.4 GHz and 5 GHz) |
| Bluetooth | Bluetooth 4.1 |
| USB Interface | USB Type-C |
| HDMI Interface | HDMI-D |
| Battery Operating Time | Approx. 3.5 hours |
| Battery Type | Dismountable and Rechargeable Li-ion Battery |
| Battery Charging Time | 5 hours to full charge |
| Protection level | IP54 |
| Power Supply | 5V DC/2A (Charging via USB) |
| Drop Test Height | 1.2 m (3.94 ft) |
| Safety | IEC 61010-1 |
| EMC | EN 301 489-1,EN 301 489-17,EN IEC 61000-6-2,EN IEC 61000-6-4,EN 61326-1 |
| Working Temperature Range | -20 °C to 50 °C (-4 °F to 122 °F) |
| Storage Temperature Range | -20 °C to 60 °C (-4 °F to 140 °F) |

| | |
|-------------------|---|
| Relative Humidity | <95 % non-condensing |
| Weight | Approx. 940 g (2.07 lb) |
| Dimension | 292.2 × 127 × 110.7 mm (11.50 × 5.00 × 4.36 in) |
| Tripod Mounting | UNC ¼"-20 |
| Vibration | 2g, IEC 60068-2-6 |
| Shock | 25 g, IEC 60068-2-27 |

▪ Available Model

HM-AP56-W/W-AI56

▪ Dimension

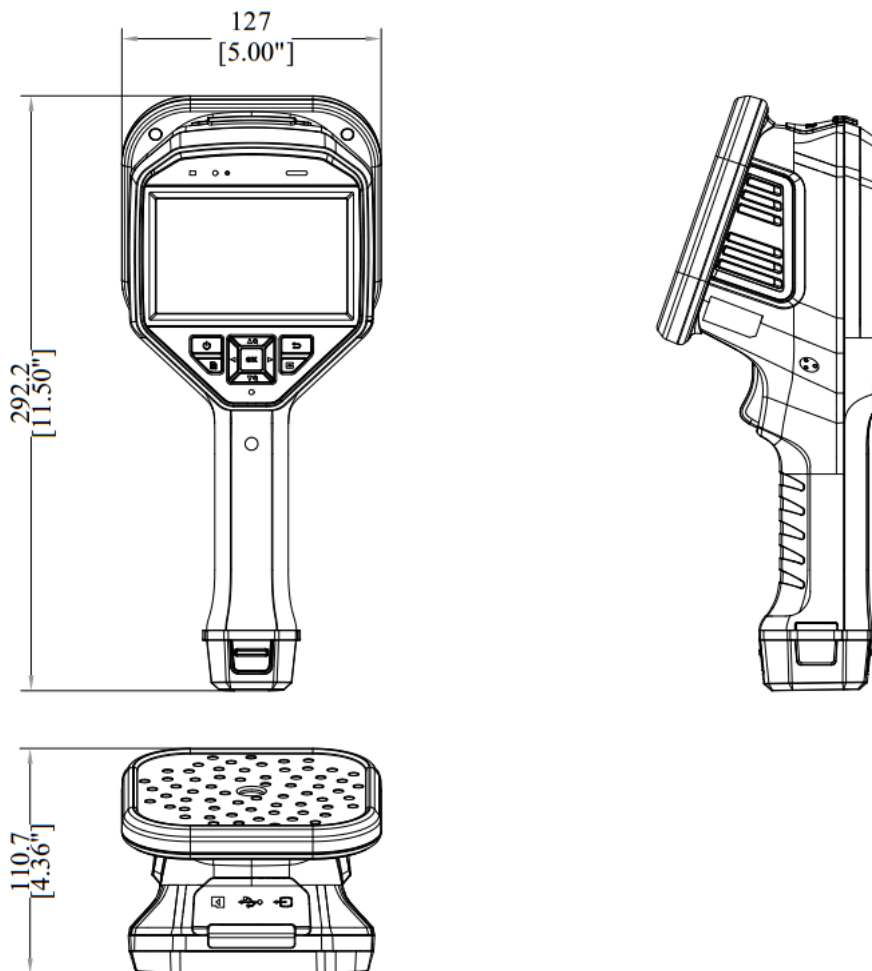

Unit: mm[Inch]

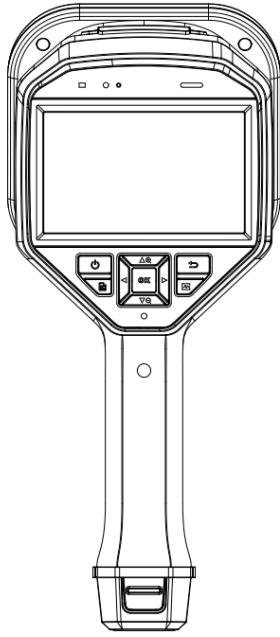

Acoustic Imaging Camera (X1)

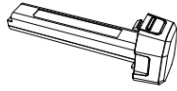

Battery (x2)

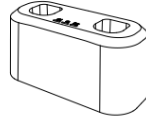

Charging Base (x1)

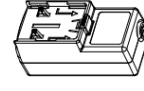

Power Adapter (x1)



Adapter (x4)



Hand Strap (x1)



USB Cable (x1)



HDMI Cable (x1)



SD Card (X1)



MIC protective case (X1)

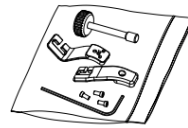

Accessories bag (x1)



Quick Start Guide (x1)

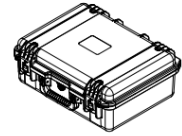

Carrying Case (x1)

